





Innovative Mining Services or as we are often referred to **Innovative Metal 'Wear' Solutions**, offer metal wear solutions to your industry.

We do so with premium products & services. With customer friendly, streamlined processes and accountability to provide the right solution, to the right customer, at the right time.



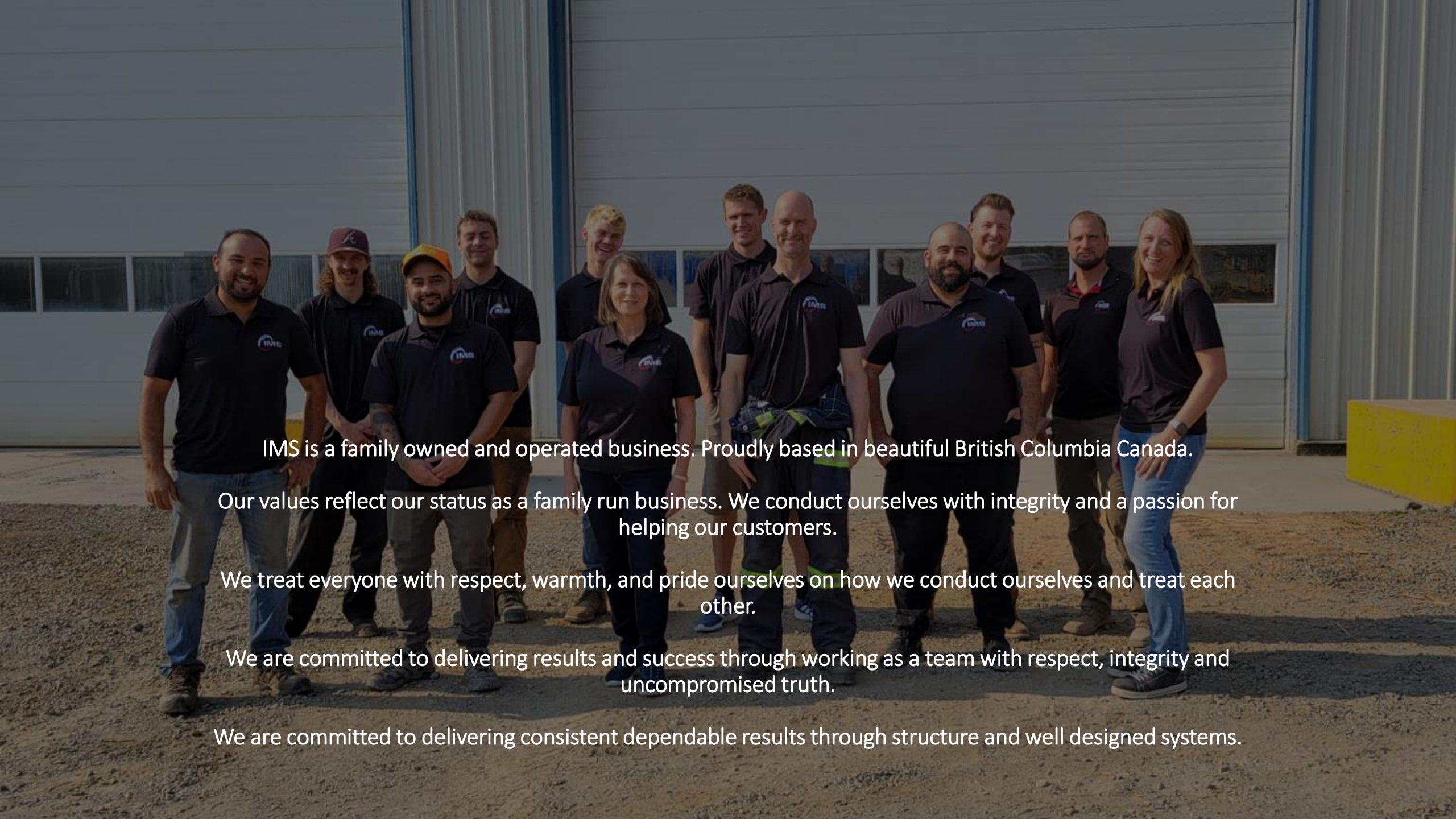

IMS is a family owned and operated business. Proudly based in beautiful British Columbia Canada.

Our values reflect our status as a family run business. We conduct ourselves with integrity and a passion for helping our customers.

We treat everyone with respect, warmth, and pride ourselves on how we conduct ourselves and treat each other.

We are committed to delivering results and success through working as a team with respect, integrity and uncompromised truth.

We are committed to delivering consistent dependable results through structure and well designed systems.

Retail
Products



Wear Plate



CCO(Chrome Carbide Overlay) Plate

Fused Plate

QT/AR Plate





IMS

Quality

44



White Iron



G.E.T
(Ground
Engaging
Tools)



Bucket
Protection
Parts

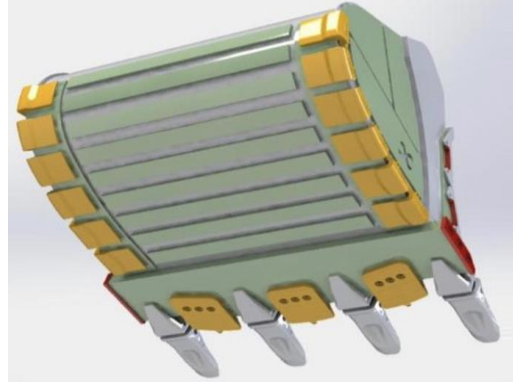

Hammers



Strikers &
Tips



Casting



Forgings



Hardware



Crusher
Wear Parts



Screens





Shop / Fabrication Services



Carbide Injection Welding and Hardfacing



Bucket & Equipment Rebuilding

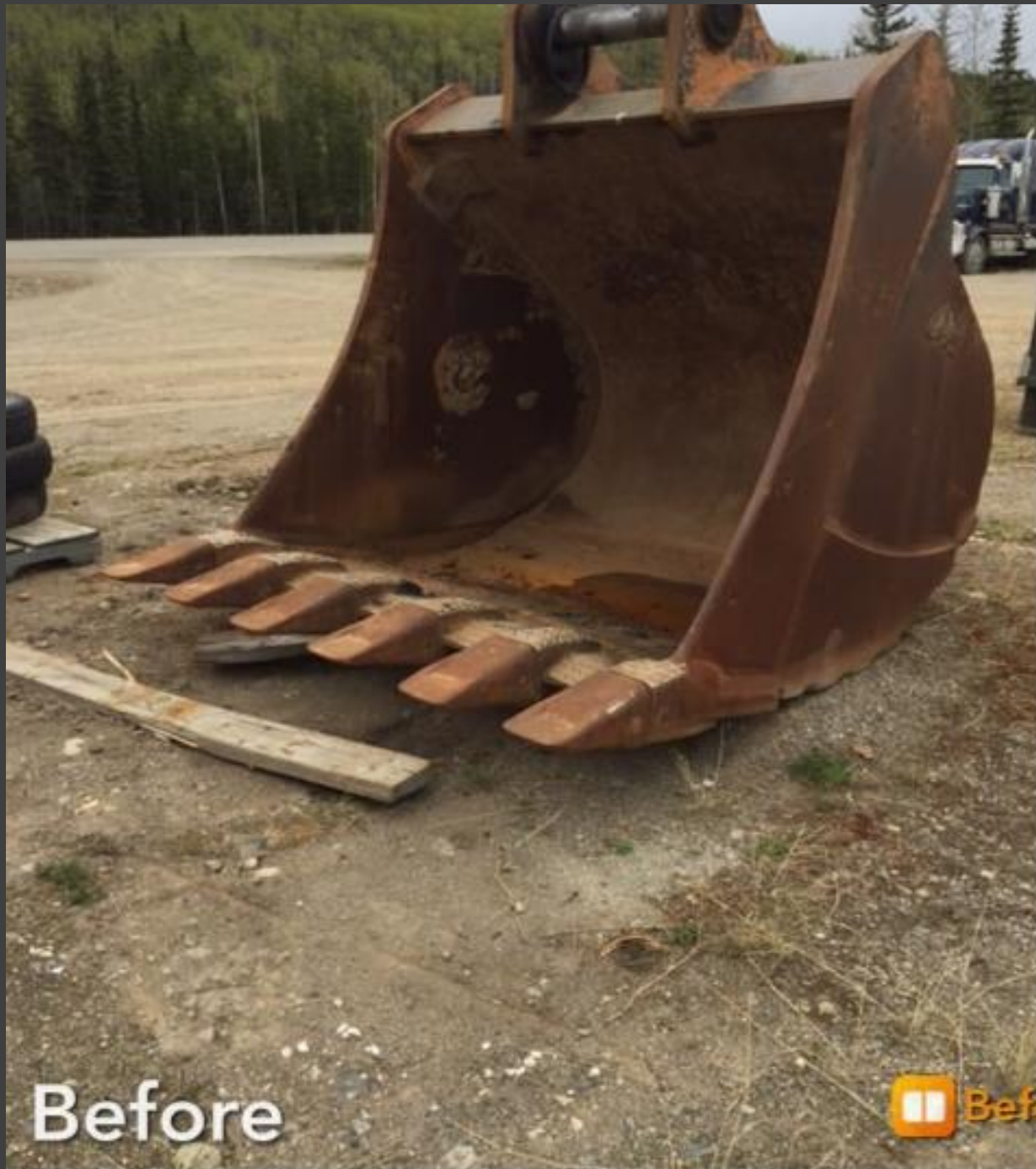

Before



After

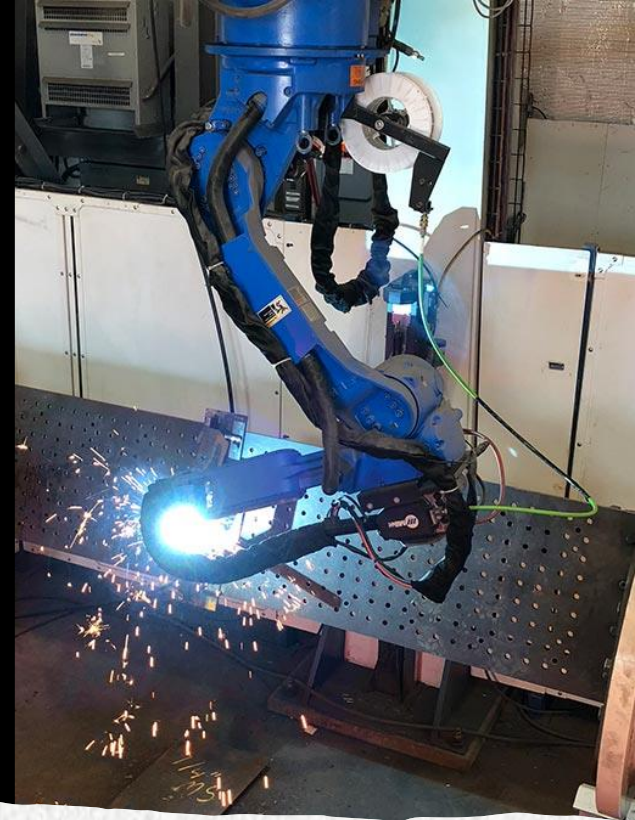

- Welding and Fabrication
- Robot Welding

CNC Plate Cutting and Brake Press Forming

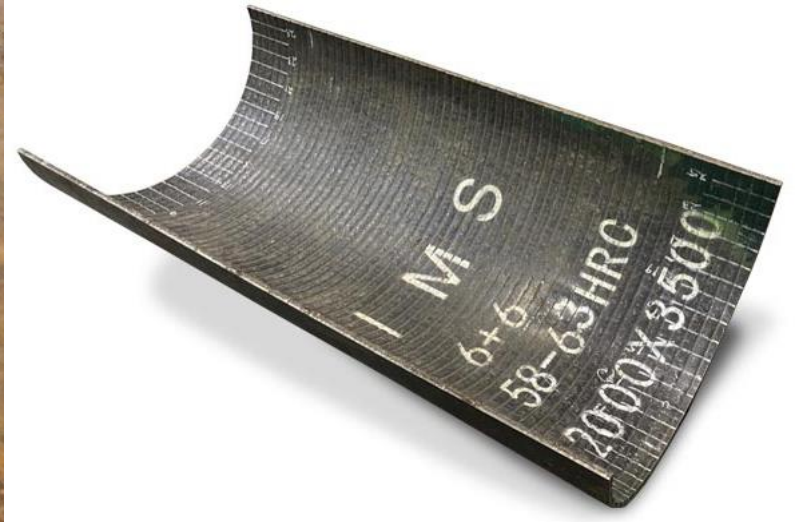
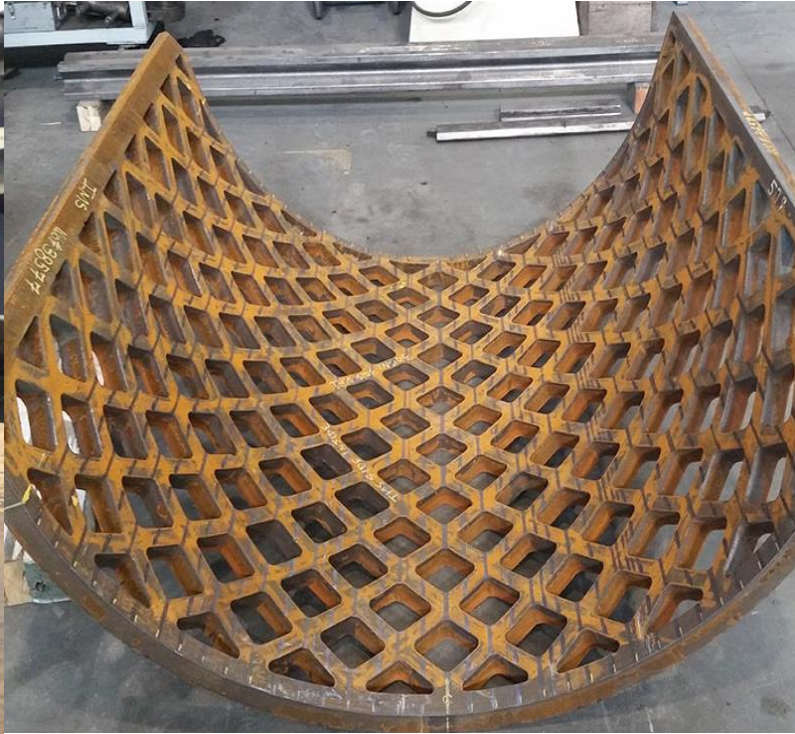

Co-Design Services

IMS Co-Design is a consulting approach to metal wear through IMS products and services. Since no two projects are alike, we work with you to provide a custom solution tailored for your individual needs.

At IMS we take pride in building lasting relationships with our clients, and share in the success of engineering wear products that are built to last.

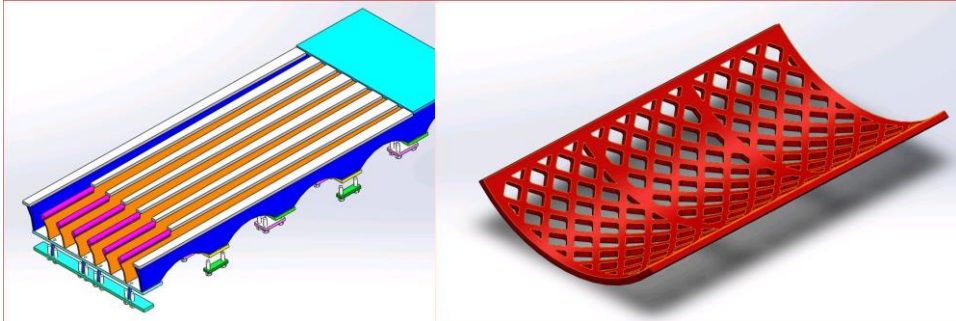

Engage
Ideate
Design
Implement
Optimize

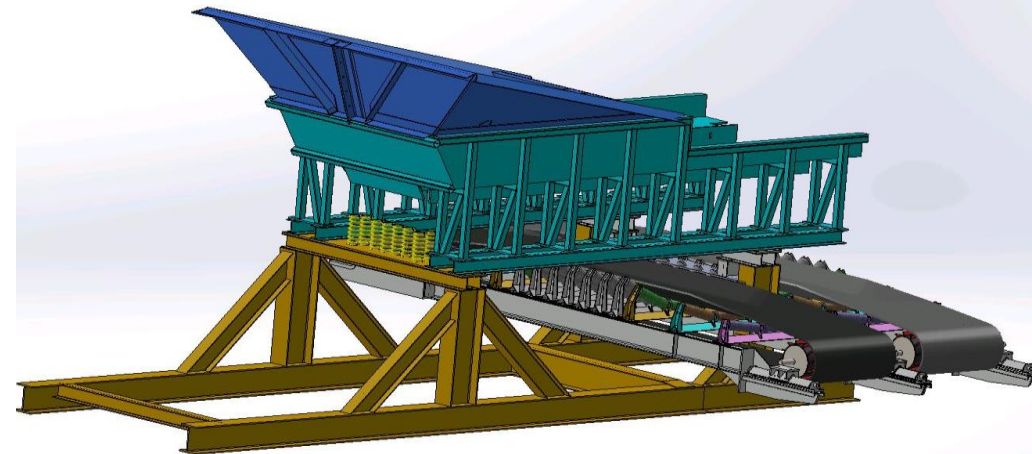
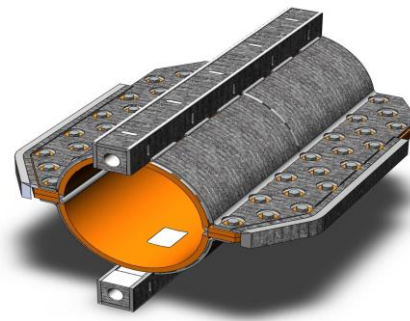
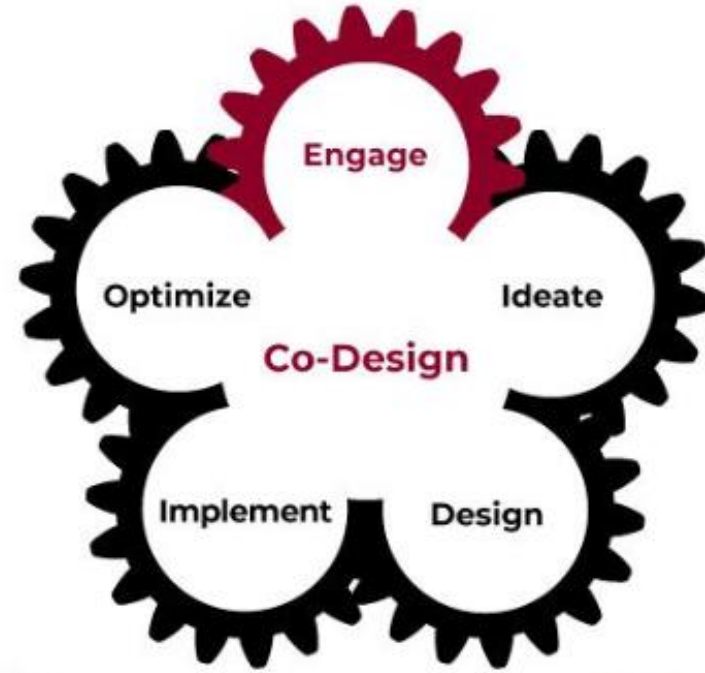





We aim to provide the right solution, to the right customer, at the right time.

We are a company focused on metal wear solutions. We provide both retail products and shop/fabrication services.

We can outperform our competition because we are a family run business with lower operating costs and because our facility allows us the flexibility to handle a wide range of products and services. Our in-house design engineering assists with our products and service solutions. We are a one-stop-shop, with in-house turn-key solutions.

We specialize in metal wear solutions for the waste & recycling sector and offer co-design services in order to support our customers. Who we want to be IMS brand ambassadors. We want our customers to enjoy working with us and see quantifiable benefits to what we provide them.

We will work with our customers to provide the ideal solution for their specific application.

My aim and satisfaction comes from supporting our customers. With premium high quality products and services, but also by building a relationship.

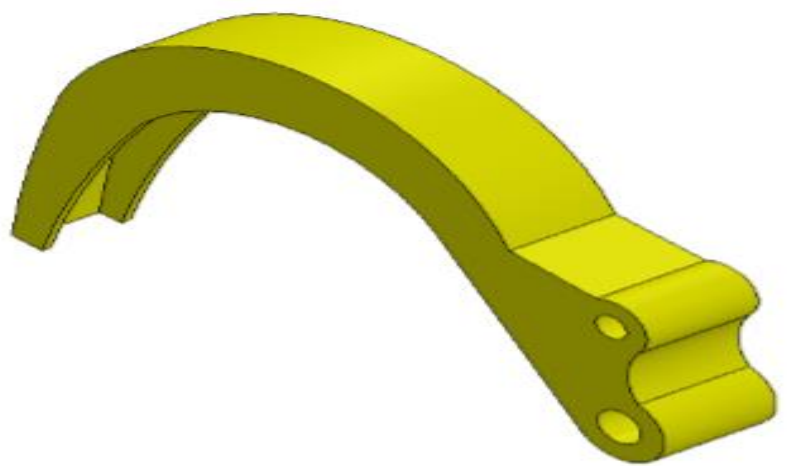
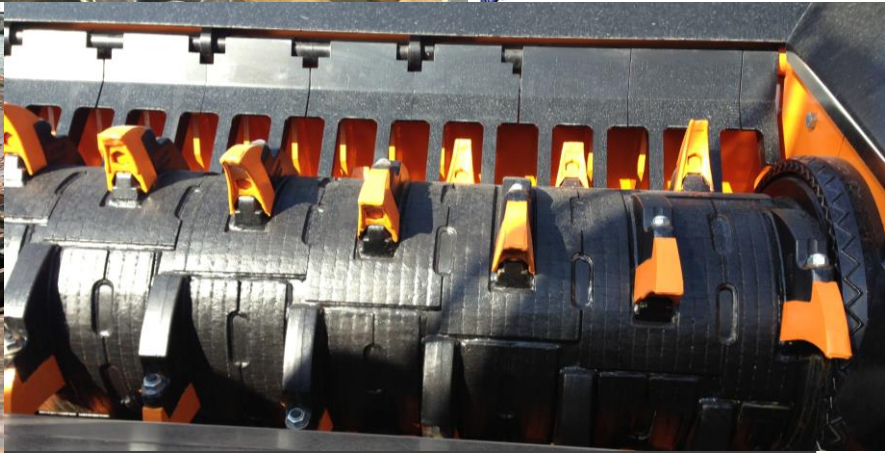
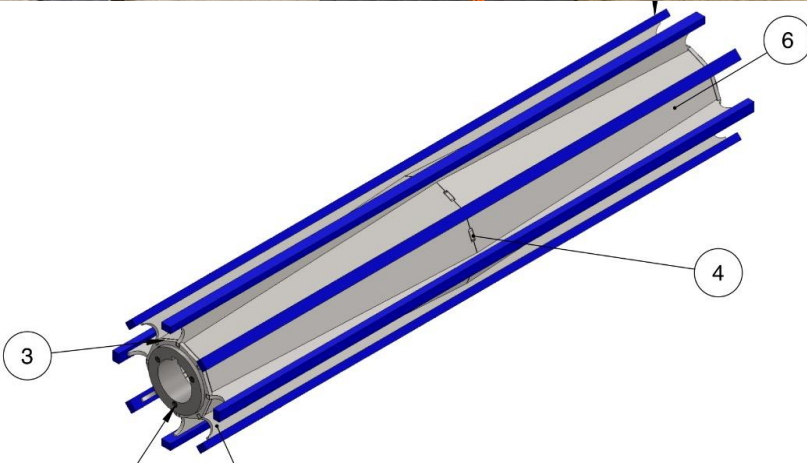
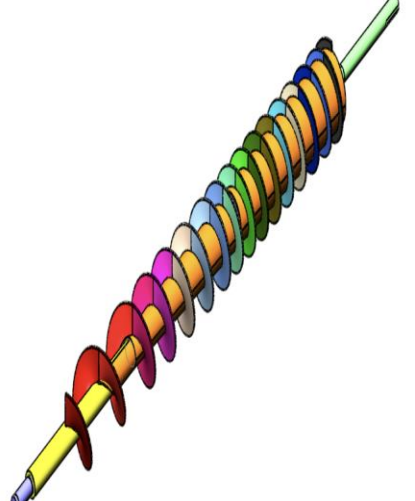

How can we help you?
What can we offer the Waste & Recycling sector?



Innovative Mining Services

Jonathon Hodgson

Sales & Marketing Manager

778-347-3584

jon@ims-group.ca

Innovative Mining Services, Inc.

37353 Ward Road Abbotsford, BC V3G 2K6

<https://ims-group.ca/>

Visit us on social media:

